















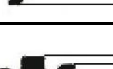

Type	Profile Code	Sectional Shape	Material	Temperature Range	Pressure ≤MPa	Seal Profile Name
Pneumatic Piston Seal	PS001		NBR,FKM	NBR:-10°C ~ 100 °C; FKM:-10°C ~ 200 °C; PU:0°C ~ 100 °C;	NBR: 1.0 FKM:1.6	QYD
	PS002		NBR,FKM,PU			QGP/YCC/AGP/GP
	PS003		NBR,FKM,PU			E4
	PS004		NBR,FKM			PZ
	PS005		NBR,FKM,PU			Z8
	PS006		NBR,FKM			APA/PSD/Double O Type/COP
	PS007		NBR,FKM			PWP/PSD/Double O Type/C Type
	PS008		RUBBER/METAL			DK,PDF
	PS009		NBR			QE
Pneumatic Rod Seal	PS010		NBR,FKM			QYd
Pneumatic Rod Wiper Seal	PS011		NBR,FKM			PDU,ZZHM
	PS012		PU,FKM			EU
	PS013		NBR,FKM			ZHM
	PS014		PU			EM
Pneumatic Cushioning Seal	PS015		NBR,FKM,PU			PP/PTQ
	PS016		NBR			MC
Pneumatic Seal Kits	SC Series	SC-32 Seal Kit	SC-40 Seal Kits	SC-50 Seal Kits	SC-63 Seal Kits	SC-80 Seal Kits
		SC-100 Seal Kits	SC-125 Seal Kits			
	SDA Series	SDA-12 Seal Kits	SDA-16 Seal Kits	SDA-20 Seal Kits	SDA-25 Seal Kits	SDA-32 Seal Kits
		SDA-40 Seal Kits	SDA-50 Seal Kits	SDA-63 Seal Kits	SDA-80 Seal Kits	SDA-100 Seal Kits
	MAL Series	MAL-16	MAL-20	MAL-25	MAL-32	MAL-40
MAL-50		MAL-63				
AirTac Cylinder Seal Kits						

PS001(QYD)

PS001 QYD is a standard piston pneumatic seal.

Material & Temperature Range:

NBR: 0°C ~ 80 °C; FKM: 0°C ~ 220 °C;

Hardness: 70 shore A Pressure: ≤1.6 MPa Speed: ≤1m/s

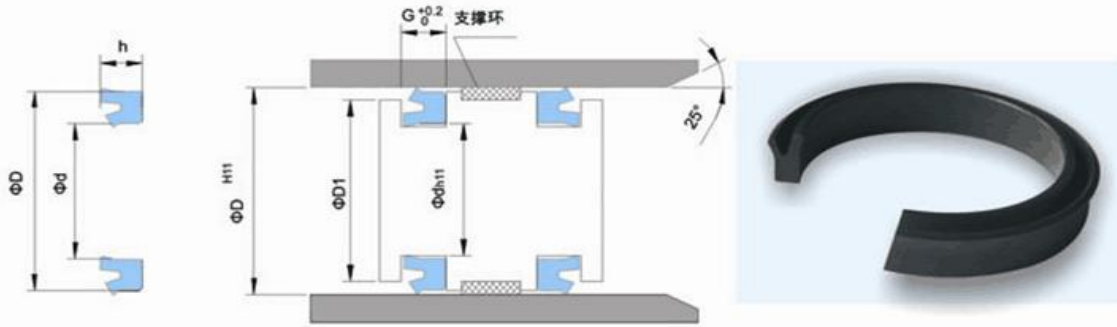

Part no.:	D	d	h	G
PS001-20	20	12	8	9
PS001-25	25	17	8	9
PS001-32	32	24	8	9
PS001-40	40	32	8	9
PS001-50	50	42	8	9
PS001-56	56	48	8	9
PS001-63	63	53	12	13
PS001-63	63	51	12	13
PS001-70	70	60	12	13
PS001-70	70	58	12	13
PS001-80	80	70	12	13
PS001-80	80	68	12	13
PS001-90	90	80	12	13
PS001-90	90	78	12	13
PS001-100	100	90	12	13
PS001-100	100	88	12	13
PS001-125	125	115	12	13
PS001-125	125	113	12	13
PS001-150	150	140	12	13
PS001-150	150	138	12	13
PS001-160	160	150	12	13
PS001-160	160	148	12	13
PS001-180	180	165	16	17
PS001-180	180	164	16	17
PS001-190	190	180	16	17
PS001-200	200	185	16	17
PS001-200	200	184	16	17
PS001-220	220	205	16	17
PS001-220	220	204	16	17
PS001-250	250	235	16	17
PS001-250	250	234	16	17
PS001-300	300	284	18	20
PS001-320	320	305	16	18
PS001-320	320	304	16	18
PS001-350	350	330	20	22
PS001-360	360	340	16	18

PS002(QGP)

PS002 QGP pneumatic piston seal has a special designed lip, it makes QGP keeps a good pre-lubricated effect, has been widely used.

Material&Temperature Range:

NBR:0°C ~ 80 °C; FKM:0°C ~ 220 °C;

Hardness:70 shore A Pressure:≤1.6 MPa Speed:≤1m/s

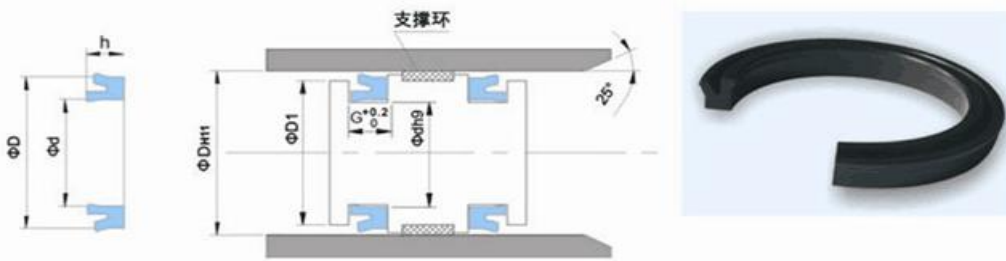

Part no.:	D	d	h	G
QGP25*17*5.2	25	17	5.2	6.0
QGP32*24*5.2	32	24	5.2	6.0
QGP40*30*6.5	40	30	6.5	7.0
QGP50*40*6.5	50	40	6.5	7.0
QGP60*50*6.5	60	50	6.5	7.0
QGP63*53*6.5	63	53	6.5	7.0
QGP70*60*6.5	70	60	6.5	7.0
QGP75*65*6.5	75	65	6.5	7.0
QGP80*70*6.5	80	70	6.5	7.0
QGP90*80*6.5	90	80	6.5	7.0
QGP100*90*7	100	90	7.0	7.5
QGP100*85*9.5	100	85	9.5	10.0
QGP125*110*9.5	125	110	9.5	10.0
QGP125*112*9.5	125	112	9.5	10.0
QGP125*113*7	125	113	7.0	7.5
QGP140*125*8.5	140	125	8.5	9.0
QGP160*145*9.5	160	145	9.5	10.0
QGP160*150*7	160	150	7.0	7.5
QGP180*165*10	180	165	10.0	11.0
QGP200*185*10	200	185	10.0	11.0
QGP200*180*12	200	180	12.0	13.0
QGP250*230*12	250	230	12.0	13.0
QGP300*280*12	300	280	12.0	13.0

PS003 E4 pneumatic piston seal has a special designed lip, it makes E4 keeps a good pre-lubricated effect, has been widely used.

Material & Temperature Range:

NBR: 0°C ~ 80 °C; FKM: 0°C ~ 220 °C;

Hardness: 70 shore A Pressure: ≤1.6 MPa Speed: ≤1m/s

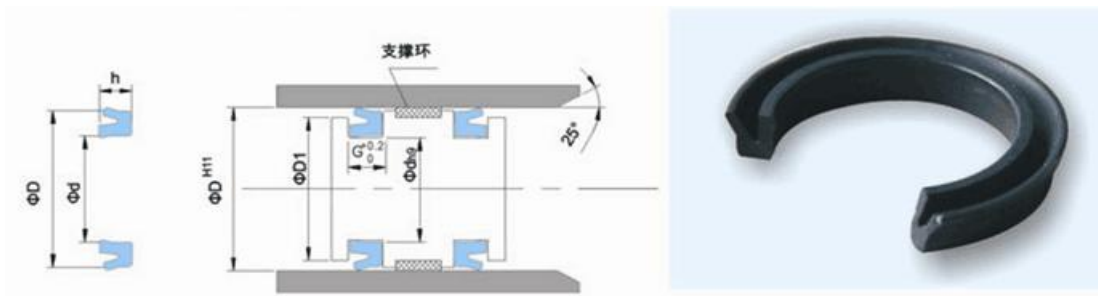

Part no.:	D	d	h	G	D1
E4-14*8*4*	14	8	4.0	4.5	13.0
E4-16*10*4*	16	10	4.0	4.5	15.0
E4-22*18*4*	22	18	4.0	4.5	21.0
E4-24*16*5.5*	24	16	5.5	6.0	23.0
E4-25*17*5.5*	25	17	5.5	6.0	24.0
E4-32*24*5.5	32	24	5.5	6.0	31.0
E4-40*30*7	40	30	7.0	7.5	38.5
E4-42*30*6*	42	30	6.0	6.5	40.5
E4-45*33*9*	45	33	9.0	9.5	31.5
E4-50*40*7	50	40	7.0	7.5	48.5
E4-63*53*7	63	53	7.0	7.5	61.5
E4-80*68*8.5	80	68	8.5	9.5	78.0
E4-99*88*9.8*	99	88	9.8	10.8	97.0
E4-100*88*8.25	100	88	8.5	9.5	98.0
E4-120*105*10*	120	105	10.0	11.0	117.5
E4-125*110*10	125	110	10.0	11.0	122.5
E4-150*135*10*	150	135	10.0	11.0	147.5
E4-160*145*10	160	145	10.0	11.0	157.5
E4-200*180*14	200	180	14.0	15.0	195.0
E4-250*230*14	250	230	14.0	15.0	245.0
E4-320*295*17	320	295	17.0	18.0	312.5

PS004(PZ)

PS004 PZ pneumatic piston seal is widely used in compact cylinders and valves, its properties as below:

- Easy installation;
- Good sealing effect;
- Special lip, work stably, low-friction.

Material & Temperature Range:

NBR: 0°C ~ 80 °C; FKM: 0°C ~ 220 °C;

Hardness: 70 shore A Pressure: ≤1.6 MPa Speed: ≤1m/s

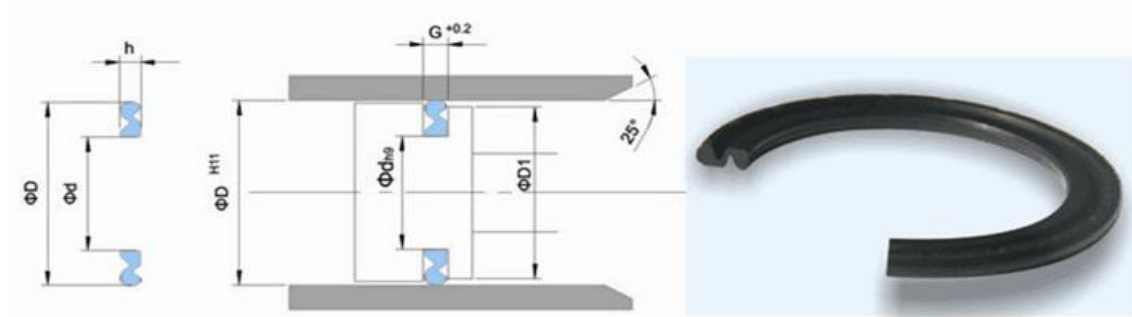

Part no.:	D	d	h	G	D1
PZ32*23*2.5	32	23	2.5	3.0	31.6
PZ40*31*2.5	40	31	2.5	3.0	39.5
PZ50*41*2.5	50	41	2.5	3.0	49.5
PZ63*51*3.4	63	51	3.4	4.0	62.5
PZ80*68*3.4	80	68	3.4	4.0	79.5
PZ100*88*3.4	100	88	3.4	4.0	99.4

PS005(Z8)

PS005 Z8 pneumatic piston seal is widely used in compact cylinders and valves, its properties as below:

- Easy installation;
- Good sealing effect;
- Special lip, work stably, low-friction.
- Could be used in dry-air conditions;
- Could be used in cylinders with buffer.

Material & Temperature Range:

NBR: 0°C ~ 80 °C; FKM: 0°C ~ 220 °C;

Hardness: 70 shore A Pressure: ≤1.6 MPa Speed: ≤1m/s



Part no.:	D	d	h	G	D1
Z8-10*6*2.55	10	6	2.55	3.00	9.60
Z8-16*10*2.55	16	10	2.55	3.00	15.60
Z8-19.7*13*3.5*	19.7	13	3.50	3.75	19.30
Z8-20*14*2.55	20	14	2.55	3.00	19.60
Z8-22*16*2.55*	22	16	2.55	3.00	21.60
Z8-25*19*3.25	25	19	3.25	3.50	24.60
Z8-28*22*3.25*	28	22	3.25	3.50	27.40
Z8-32*24*3.25	32	24	3.25	3.50	31.40
Z8-37*29*3.25*	37	29	3.25	3.50	36.40
Z8-40*32*3.25	40	32	3.25	3.50	39.40
Z8-50*42*3.25	50	42	3.25	3.50	49.40
Z8-63*53*4.25	63	53	4.25	4.50	62.40
Z8-75*65*5*	75	65	5.00	5.25	74.40
Z8-80*70*4.25	80	70	4.25	4.50	79.40
Z8-90*80*4.25	90	80	4.25	4.50	89.40
Z8-100*90*4.25	100	90	4.25	4.50	99.40
Z8-125*105*8.25	125	105	8.25	8.50	123.80
Z8-150*130*8.25	150	130	8.25	8.50	148.80
Z8-160*140*8.25	160	140	8.25	8.50	158.80
Z8-200*180*8.25	200	180	8.25	8.50	198.80

PS006(APA/COP)

PS006 is a standard piston seal.

Material&Temperature Range:

NBR:0°C ~ 80 °C; FKM:0°C ~ 220 °C;

Hardness:70 shore A

Pressure:≤1.6 MPa

Speed:≤1m/s

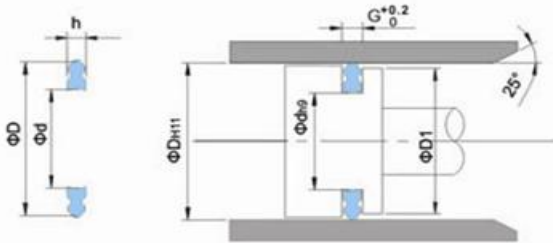

Part no.:	D	d	h	G	D1
PS006-10	10	5.4	1.60	2.20	9.70
PS006-12	12	7.4	1.60	2.20	11.70
PS006-16	16	11.4	1.60	2.20	15.70
PS006-20	20	14	2.20	2.50	19.50
PS006-25	25	17	3.00	3.20	24.50
PS006-32	32	24	3.00	3.20	31.50
PS006-40	40	32	3.00	3.20	39.50
PS006-50	50	40	3.80	4.20	49.50
PS006-63	63	53	3.80	4.20	62.40
PS006-80	80	65	5.60	6.00	79.50
PS006-100	100	85	5.60	6.00	99.40
PS006-125	125	109	5.60	6.00	124.40
PS006-140	140	122.3	6.50	6.90	139.40
PS006-160	160	140	7.50	7.90	159.40
PS006-200	200	180	7.50	7.90	199.40

PS007(PWP)

PS007 PWP used in light-duty cylinders, comparing with PS006 it has a better structure design, its spring section make it has lower friction and good sealing effect.

Material&Temperature Range:

NBR:0°C ~ 80 °C; FKM:0°C ~ 220 °C;

Hardness:70 shore A Pressure:≤1.6 MPa Speed:≤1m/s

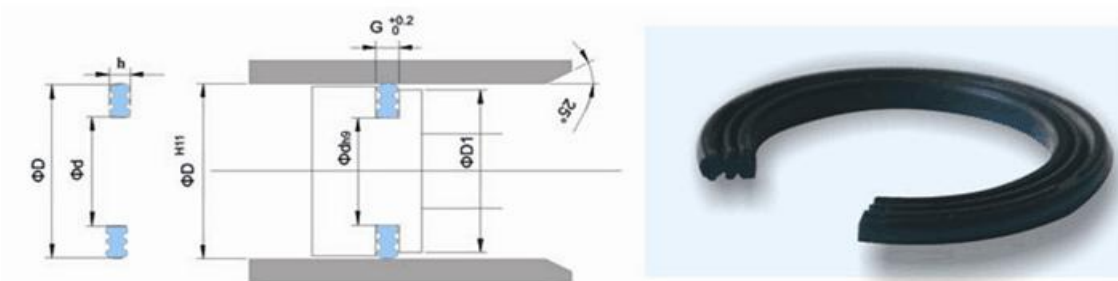

Part no.:	D	d	h	G	D1
PWP32*24*2.8	32	24	2.80	3.20	31.50
PWP40*32*2.8	40	32	2.80	3.20	39.50
PWP50*40*3.6	50	40	3.60	4.00	49.50
PWP63*53*3.6	63	53	3.60	4.00	62.50
PWP70*60*3.6	70	60	3.60	4.00	69.50
PWP80*65*5.4	80	65	5.40	6.00	79.50
PWP100*85*5.4	100	85	5.40	6.00	99.50
PWP125*110*5.4	125	110	5.40	6.00	124.50
PWP140*125*5.4	140	125	5.40	6.00	139.50
PWP150*135*5.4	150	135	5.40	6.00	149.50
PWP160*140*7.4	160	140	7.40	8.00	159.50
PWP200*180*7.4	200	180	7.40	8.00	199.00
PWP210*190*7.4	210	190	7.40	8.00	209.00
PWP250*230*7.4	250	230	7.40	8.00	249.00
PWP280*260*7.4	280	260	7.40	8.00	279.00
PWP300*280*7.4	300	280	7.40	8.00	299.00
PWP350*330*7.4	350	330	7.40	8.00	349.00

PS008(DK/DP)

PS008 DK is a double acting piston seal,widely used in auto industries.

Material&Temperature Range:

NBR:0℃ ~ 100 ℃; FKM:-20℃ ~ 220 ℃;

Pressure:≤1.6 MPa Speed:≤1m/s

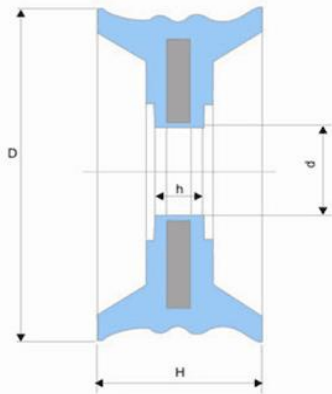

Size D*d*H	Size D*d*H	Size D*d*H
DK 16*4*7	DK 63*16*21.5	DK 200*20*40
DK 16*5*12	DK 75*12*22	DK 200*27*35
DK 20*5*12	DK 75*16*25	DK 200*30*30
DK 20*6*12	DK 80*12*22.5	DK 200*30*35
DK 20*6*7	DK 80*12*23	DK 220*25*40
DK 25*12(no hole)	DK 80*12*25	DK 250*30*40
DK 25*6*12	DK 80*14*23	DP
DK 25*7*8.8	DK 80*16*22.5	DP 16*4.5*6.5
DK 25*8*12	DK 80*16*24	DP 20*6*7.5
DK 30*8*18	DK 80*16*25	DP 25*7*8.5
DK 32*15(no hole)	DK 80*18*25	DP 25*8*7
DK 32*5*18	DK 80*20*22.5	DP 32*10*8.8
DK 32*6*15	DK 90*12*25	DP 32*8*10
DK 32*8*15	DK 95*12*25	DP 32*8*11
DK 40*10*18	DK 100*12*25	DP 32*8*8.8
DK 40*8*18	DK 100*16*25	DP 40*10*14
DK 40*8*20	DK 100*18*25	DP 40*8*11.8
DK 50*10*18	DK 100*20*18	DP 50*10*14
DK 50*10*24	DK 125*18*30	DP 50*12*10
DK 50*16*20	DK 125*20*26	DP 50*12*14
DK 50*16*20.5	DK 125*20*28	DP 60*10*14
DK 50*8*20	DK 130*20*29	DP 63*10*17
DK 60*12*21	DK 140*20*28	DP 80*16*16
DK 60*12*22	DK 140*22*29	DP 100*16*16
DK 60*12*27(spring)	DK 150*20*29	DP 100*17*18.5
DK 60*16*22	DK 160*20*26	DP 100*20*26
DK 60*18*21	DK 160*24*28	DP 63*10*17
DK 63*12*14	DK 160*27*29	DP 80*16*16
DK 63*12*22	DK 160*30*29	DP 100*16*16
DK 63*14*14	DK 190*18*32	DP 100*17*18.5
DK 63*14*22	DK 200*27*30	DP 100*20*26

For sizes not listed,please request.

PS009(QE)

PS009 QE is used in manually operation pneumatic valves.

Material&Temperature Range:

NBR:0°C ~ 80 °C; FKM:0°C ~ 220 °C;

Hardness:70 shore A Pressure:≤1.6 MPa Speed:≤1m/s

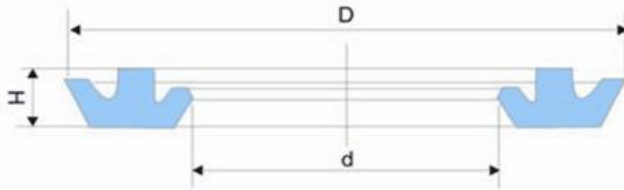

Part no.:	D	d	H
QE10*5*2.5	10	5	2.50
QE16*7*2.2	16	7	2.20
QE18*9*2.2	18	9	2.20
QE22*12*2.2	22	12	2.20
QE25*14*3.5	25	14	3.50
QE30*18*3.6	30	18	3.60
QE32*18*3.6	32	18	3.60
QE40*25*3.5	40	25	3.50
QE50*32*4.2	50	32	4.20
QE49*32*6.5	49	32	6.50
QE65*47*6.7	65	47	6.70

PS010(QYd)

PS010 QYd is a standard single-acting rod pneumatic seal.

Material&Temperature Range:

NBR:0°C ~ 80 °C; FKM:0°C ~ 220 °C;

Hardness:70 shore A Pressure:≤1.6 MPa Speed:≤1m/s

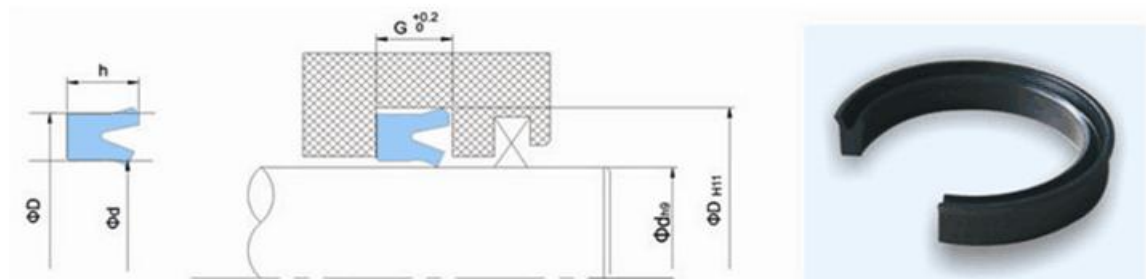

Part no.:	d	D	h	G
QYd6*12*7	6	12	7.00	8.00
QYd8*14*7	8	14	7	8.00
QYd10*16*7	10	16	7.00	8.00
QYd12*18*7	12	18	7	8.00
QYd16*24*8	16	24	8.00	9.00
QYd20*28*8	20	28	8	9.00
QYd25*33*8	25	33	8.00	9.00
QYd32*40*8	32	40	8	9.00
QYd40*48*8	40	48	8.00	9.00
QYd45*53*8	45	53	8	9.00
QYd50*60*12	50	60	12.00	13.00
QYd60*70*12	60	70	12	13.00
QYd63*73*12	63	73	12.00	13.00
QYd70*80*12	70	80	12	13.00
QYd80*90*12	80	90	12.00	13.00
QYd90*100*12	90	100	12	13.00
QYd100*110*12	100	110	12.00	13.00

PS011(ZZHM)

PS011 ZZHM is a rod and wiper pneumatic seal.

Material&Temperature Range:

NBR:0°C ~ 80 °C; FKM:0°C ~ 220 °C;

Hardness:70 shore A Pressure:≤1.6 MPa Speed:≤1m/s

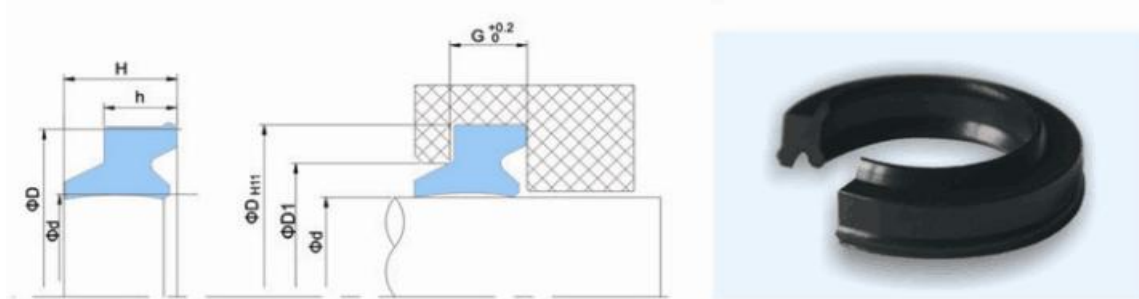

Part no.:	d	D	h	H	G	D1
ZZHM6*11	6	11	4.00	5.00	4.50	7.60
ZZHM6*10	6	10	3.80	4.70	4.50	7.60
ZZHM8*12	8	12	3.80	4.70	4.50	9.60
ZZHM10*14	10	14	3.80	4.70	4.50	11.60
ZZHM12*16	12	16	3.80	4.70	4.50	13.60
ZZHM14*18	14	18	3.80	4.70	4.50	15.60
ZZHM16*24	16	24	5.70	7.10	6.00	19.40
ZZHM20*28	20	28	5.70	7.10	6.00	23.40
ZZHM22*30	22	30	5.70	7.10	6.00	25.40
ZZHM25*33	25	33	5.70	7.10	6.00	28.40
ZZHM30*40	30	40	6.00	7.30	6.00	34.00
ZZHM32*42	32	42	6.50	8.50	7.00	36.00
ZZHM35*45	35	45	6.50	7.90	7.00	39.00
ZZHM40*50	40	50	6.50	7.90	7.00	44.00
ZZHM45*55	45	55	6.50	7.90	7.00	49.00
ZZHM50*60	50	60	6.50	7.90	7.00	54.00

PS012 EU rod and wiper pneumatic seal has good function of sealing, dustproof and fixing. As the specially designed lips, it shows good properties of low-friction and long-service life.

Material & Temperature Range:

PU: 0°C ~ 100 °C; FKM: -20°C ~ 220 °C;

Hardness: 70 shore A

Pressure: ≤1.6 MPa

Speed: ≤1m/s

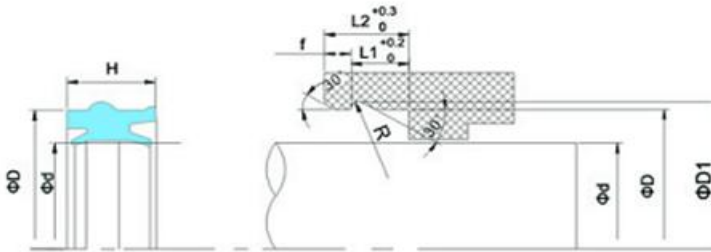

Part no.:	d	D	H	D1	L1	L2	R	f
EU12*19*10	12	19	10	21	7.7	12	1	1.5
EU12*20*10.7	12	20	10.7	22	8.8	12	1.1	1.5
EU12*22*10.7*	12	22	10.7	24	8.8	12	1.1	1.5
EU14*24*10.7	14	24	10.7	26	8.8	13	1.1	1.5
EU16*26*10.7	16	26	10.7	28	8.8	13	1.1	1.5
EU18*26*10.7*	18	26	10.7	28	8.8	13	1.1	1.5
EU18*28*10.7	18	28	10.7	30	8.8	13	1.1	1.5
EU20*30*10.7	20	30	10.7	32	8.8	13	1.4	1.5
EU22*32*11.2	22	32	11.2	34.5	9.4	14	1.4	2
EU25*35*11.2	25	35	11.2	37.5	9.4	14	1.4	2
EU30*40*11.2*	30	40	11.2	42.5	9.4	14	1.4	1.5
EU32*42*10.7*	32	42	10.7	44.5	8.8	13	1.4	1.5
EU32*42*11.2	32	42	11.2	44.5	9.4	14	1.4	2
EU40*50*11.2	40	50	11.2	53.2	9.4	14	1.4	2
EU45*55*12.2*	45	55	12.2	58.2	10.4	15	1.8	2
EU50*60*12.2	50	60	12.2	63.2	10.4	15	1.8	2
EU63*75*13	63	75	13	78.2	11.4	16	1.8	2

PS013(ZHM)

PS013 ZHM is a rod and wiper pneumatic seal.

Material&Temperature Range:

NBR:0°C ~ 80 °C;

FKM:0°C ~ 220 °C;

Hardness:70 shore A

Pressure:≤1.6 MPa

Speed:≤1m/s

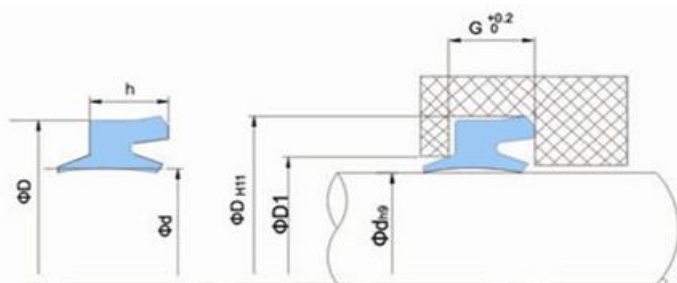

Part no.	Size mm	d	D	h	H	G	D1
ZHM-8	8*14*7/9	8	14	7.00	9.00	8.00	11.00
ZHM-10	10*16*7/9	10	16	7.00	9.00	8.00	13.00
ZHM-12	12*18*7/9	12	18	7.00	9.00	8.00	15.00
ZHM-14	14*20*7/9	14	20	7.00	9.00	8.00	17.00
ZHM-15	15*21*7/9	15	21	7.00	9.00	8.00	18.00
ZHM-16	16*22*7/9	16	22	7.00	9.00	8.00	19.00
ZHM-18	18*24*7/9	18	24	7.00	9.00	8.00	21.00
ZHM-20	20*28*8/11	20	28	8.00	11.00	9.00	24.00
ZHM-22	22*30*8/11	22	30	8.00	11.00	9.00	26.00
ZHM-25	25*33*8/11	25	33	8.00	11.00	9.00	29.00
ZHM-28	28*36*8/11	28	36	8.00	11.00	9.00	32.00
ZHM-30	30*38*8/11	30	38	8.00	11.00	9.00	34.00
ZHM-32	32*40*8/11	32	40	8.00	11.00	9.00	36.00
ZHM-35	35*43*8/11	35	43	8.00	11.00	9.00	39.00
ZHM-36	36*44*8/11	36	44	8.00	11.00	9.00	40.00
ZHM-40	40*48*8/11	40	48	8.00	11.00	9.00	44.00
ZHM-45	45*53*6.5	45	53	6.50	10.00	9.00	49.00
ZHM-45/1	45*57*11/15	45	57	11.00	15.00	12.00	52.00
ZHM-50	50*62*11/15	50	62	11.00	15.00	12.00	56.00
ZHM-55	55*67*11/15	55	67	11.00	15.00	12.00	51.00
ZHM-60	60*72*11/15	60	72	11.00	15.00	12.00	65.00
ZHM-63	63*75*11/15	63	75	11.00	15.00	12.00	68.00
ZHM-65	65*77*11/15	65	77	11.00	15.00	12.00	70.00
ZHM-70	70*82*11/15	70	82	11.00	15.00	12.00	75.00
ZHM-70/1	70*80.5*11/15	70	82	11.00	15.00	12.00	75.00
ZHM-75	75*87*11/15	75	87	11.00	15.00	12.00	80.00
ZHM-80	80*92*11/15	80	92	11.00	15.00	12.00	85.00
ZHM-85	85*97*11/15	85	97	11.00	15.00	12.00	90.00
ZHM-90	90*102*11/15	90	102	11.00	15.00	12.00	95.00

PS014(EM)

PS014 EM is widely used in light-duty pneumatic cylinders.

Material&Temperature Range:

PU:0°C ~ 100 °C;

Hardness:90 shore A

Pressure:≤1.6 MPa

Speed:≤1m/s

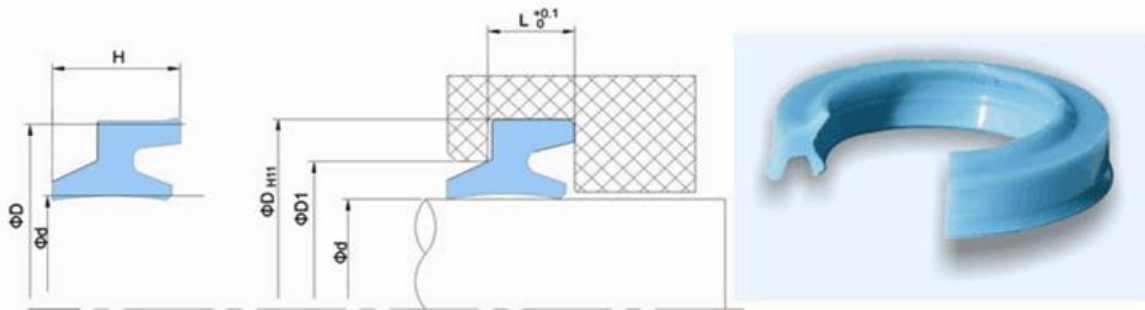

Part no.:	d	D	H	D1	L
EM4*7*2.8	4	7	2.80	86.00	2.70
EM6*9*2.8	6	9	2.80	8.10	2.70
EM8*11.5*3.2	8	11.5	3.20	10.10	3.00
EM10*14*3.7	10	14	3.70	12.10	3.40
EM12*16.5*4	12	16.5	4.00	14.10	3.70
EM16*20.5*4	16	20.5	4.00	18.10	3.70
EM20*25*4.6	20	25	4.60	23.10	4.15
EM25*30*4.6	25	30	4.60	26.90	4.15
EM30*35.5*5	30	35.5	5.00	32.10	4.55
EM32*37.5*5	32	37.5	5.00	34.10	4.55
EM40*46*5.5	40	46	5.50	42.20	4.90
EM50*56*5.5	50	56	5.50	52.20	4.90

PS014(PP)

PS015 PP is specially designed for cushioning pistons in pneumatic cylinders.

Material&Temperature Range:

NBR:0°C ~ 100 °C; FKM:-20°C ~ 220 °C; PU:0°C ~ 100 °C;

Pressure:≤1.6 MPa

Speed:≤1m/s

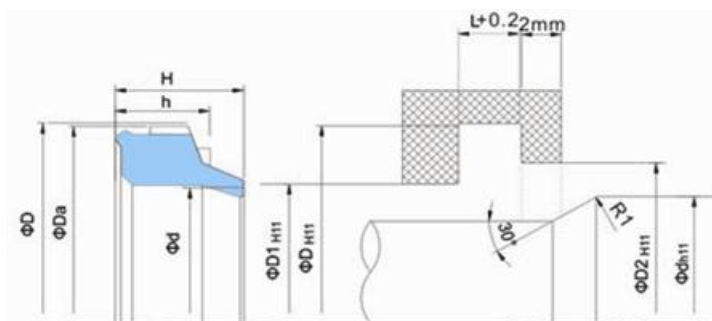

Part no.:	d	D	H	h
PP8*11.5*3.7	8	11.5	3.70	2.80
PP9.5*15*4.6	9.5	15	4.60	3.70
PP12*18*5.2	12	18	5.20	4.20
PP12*20*5.5*	12	20	5.50	4.50
PP12*20*7.8*	12	20	7.80	6.00
PP14*22*7.8*	14	22	7.80	6.00
PP16*22*5.5	16	22	5.50	4.50
PP16*24*7.8*	16	24	7.80	6.00
PP20*28*7.8	20	28	7.80	6.00
PP22*30*7.8*	22	30	7.80	6.00
PP25*33*7.8	25	33	7.80	6.30
PP28*36*7.8	28	36	7.80	6.30
PP30*38*7.8*	30	38	7.80	6.30
PP30*40*7.8	30	40	7.80	6.30
PP32*42*7.8	32	42	7.80	6.00
PP36*46*7.8	35	45	7.80	5.70
PP40*50*7.8	40	50	7.80	6.20
PP45*55*7.8	45	55	7.80	6.30
PP50*60*7.8	50	60	7.80	6.40
PP55*70*8.5	55	70	8.50	7.20
PP57*74*11*	57	74	11.00	9.30
PP70*87*10.5	70	87	10.50	9.00
PP80*98*11	80	98	11.00	9.30
PP90*109*11.5	90	109	11.50	9.50

PS016(MC)

PS016 MC buffer seal is a cushioning seal specially designed for the pneumatic cylinder. Its design has the following advantages:

1. It acts as a check valve in the whole sealing system, so that it is no longer necessary to add other check valves to the system;
2. Automatically selected buffer stroke;
3. Even in the case of slight eccentricity, it has good cushioning effect because it can be automatically centered;
4. Because it has two independent sealing systems (movable sealing lip and Axial sealing area), thus increasing the reliability of the system;
5. Easy to install.



Material: NBR

Working environment

Temperature: -20 ° C - +100 ° C

Medium: Oil-lubricated air as well as dry air and oil-free air (primary lubrication required for assembly).

Pressure: 1.6 ≤ MPa

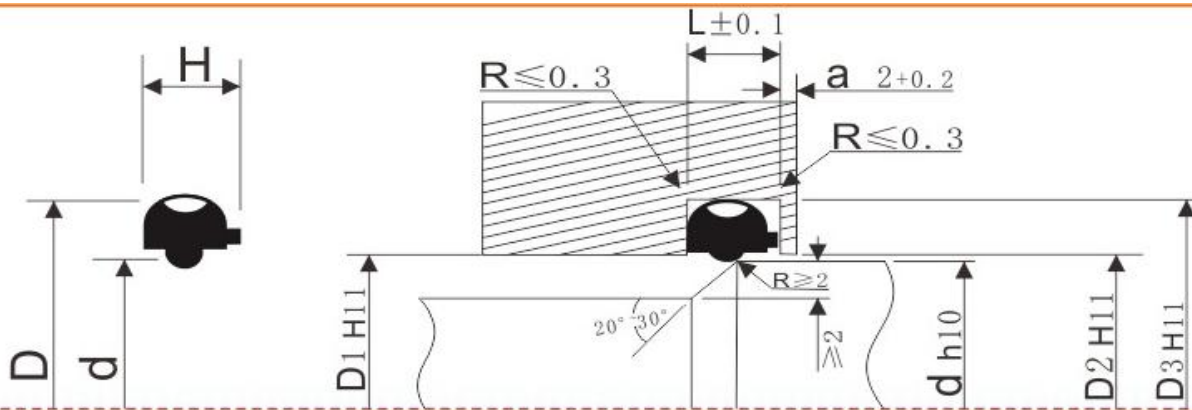

Part no.	d	D	H	D1	D2	D3	L
MC-16	16	22	4.50	17.00	17.00	22.50	5.00
MC-20	20	28	4.50	21.00	21.00	28.5	5.00
MC-28	28	36	5.00	29.00	29.00	36.50	5.50
MC-35	35	45	6.00	36.00	36.00	45.50	6.50
MC-45	45	55	6.00	46.00	46.00	55.50	6.50
MC-48	48	58	7.50	49.00	49.00	58.50	8.00

If the size you are looking for not in the list, please request.